

PC-100
Cod. 111000

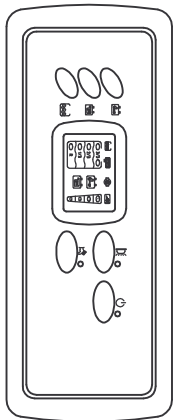

PC-200
Cod. 112001

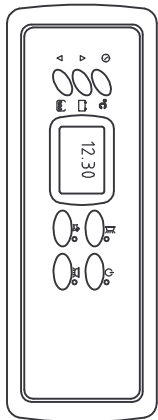

N°	DESCRIZIONE
01	SEC
02	SW
03	VCC
04	GND

for version
PC-200

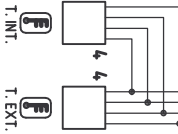

N°	PIN	DESCRIZIONE
01	"J09"	POT 1/3
02	01	GND
03	02	R.LEXT
04	04	CORONA
05	05	POT 2/3
07	07	POT 2/3
08	08	POT 2/3
09	09	S.A.GND
10	10	P.C.GND
11	11	B1
12	12	REC 1/3
13	13	C.GEN
14	14	B2
15	15	/
16	16	/

PIN	DESCRIZIONE	AGND
01	"J06"	REC 1/3_REC 3/3
02	01	AGND
03	02	POT 1/3
04	04	POT 2/3

PIN	DESCRIZIONE	AGND
01	"J03"	POT 1/3
02	02	POT 1/3
03	03	POT 2/3
04	04	POT 3/3

This drawing obtained from <http://www.marcleisure.co.uk>
Suppliers of cbe modular electrical fittings

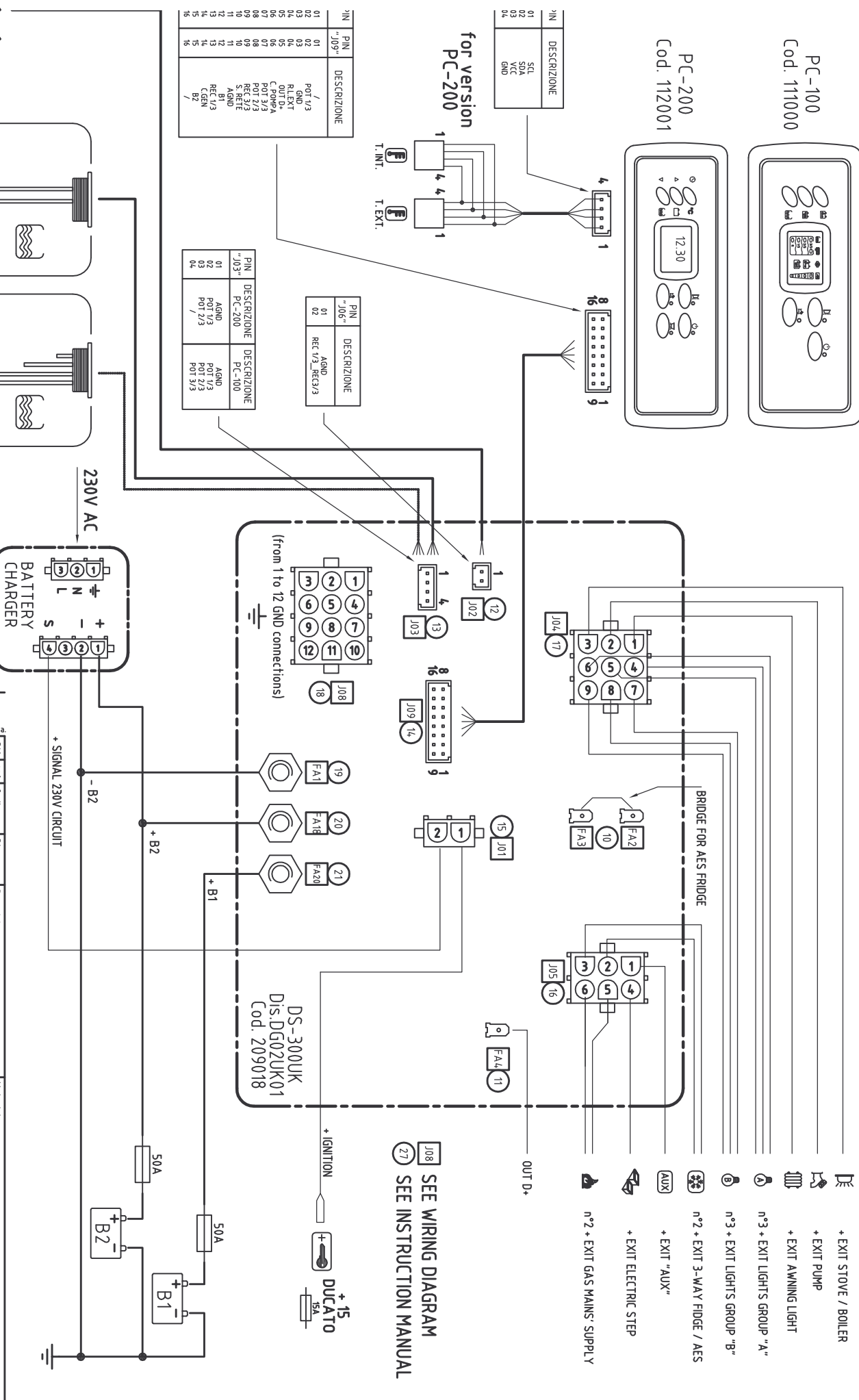

WASTE WATER

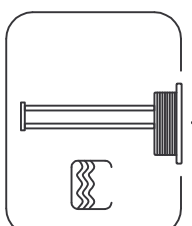

DRINK WASTE WATER
for version PC-200

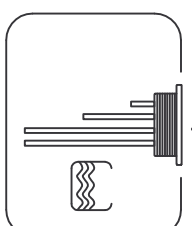

for version PC-100

AUTOCAD - A3		Sostituiscice il:	
Sostituito da:		REVISIONI	
Rev.	Data	Descrizione	
Firma			
Disegno			
Codice			
Rif. Qta			
DESCRIZIONE: Schema elettrico generale "PC-100 - PC-200 / DS-300UK"			
Materiale			
Trattamento e/o finiture:			
Elab. Data: 24/01/04			
Appr. Data:			
Firma: A. Fogaroli			
CODICE			
/			
Famiglia prod.: Arch.: DG01			
SCHEMI ELETTRICI COMUNI			
Scala: /			
Toll.gen. /			
N° Fogli: 1/1			
N° DISEGNO			
DG01UK01.A			

Disegno di proprietà esclusiva della CBE S.n.c. TN, è vietata la riproduzione e la comunicazione a terzi senza autorizzazione scritta. Mod. 21/30

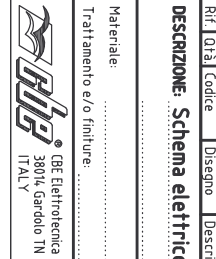

DS-300UK
Dis. DG02UK01
Cod. 209018

SEE WIRING DIAGRAM
SEE INSTRUCTION MANUAL

IGNITION

DUCATO 15A

50A

B2

B1

50A

- EXIT STOVE / BOILER
- EXIT PUMP
- EXIT AWNING LIGHT
- n°2 + EXIT 3-WAY RIDGE / AES
- EXIT "AUX"
- EXIT ELECTRIC STEP
- n°2 + EXIT GAS MAINS SUPPLY
- OUT D+
- FA1
- FA2
- FA3
- FA4
- FA5
- FA6
- FA7
- FA8
- FA9
- FA10
- FA11
- FA12
- FA13
- FA14
- FA15
- FA16
- FA17
- FA18
- FA19
- FA20
- FA21
- FA22
- FA23
- FA24
- FA25
- FA26
- FA27
- FA28
- FA29
- FA30
- FA31
- FA32
- FA33
- FA34
- FA35
- FA36
- FA37
- FA38
- FA39
- FA40
- FA41
- FA42
- FA43
- FA44
- FA45
- FA46
- FA47
- FA48
- FA49
- FA50
- FA51
- FA52
- FA53
- FA54
- FA55
- FA56
- FA57
- FA58
- FA59
- FA60
- FA61
- FA62
- FA63
- FA64
- FA65
- FA66
- FA67
- FA68
- FA69
- FA70
- FA71
- FA72
- FA73
- FA74
- FA75
- FA76
- FA77
- FA78
- FA79
- FA80
- FA81
- FA82
- FA83
- FA84
- FA85
- FA86
- FA87
- FA88
- FA89
- FA90
- FA91
- FA92
- FA93
- FA94
- FA95
- FA96
- FA97
- FA98
- FA99
- FA100